

Waterproof Junction Box - INSX132

Material: Aluminum

Dimensions: 150mm x 150mm x 40mm

Color: White

Type of Installation: Wall

Net Weight: 0.6kg

Load Bearing Capacity: 3kg



Applications

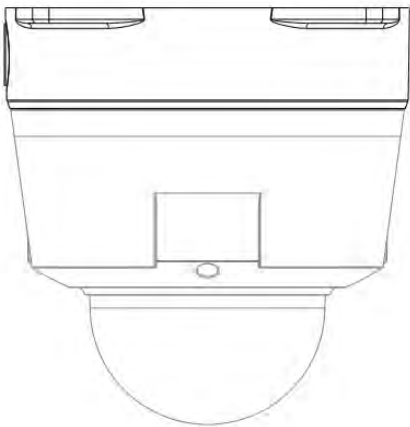

Dimensions (mm)

